

2
4





2024 - PORTE IMIC Spa
© Copyright - All rights reserved
Tutti i diritti sono riservati.

È vietato qualsiasi utilizzo, totale o parziale, dei contenuti inseriti nel presente catalogo, ivi inclusa la riproduzione, rielaborazione, diffusione o distribuzione dei contenuti stessi mediante qualunque supporto o rete telematica senza previa autorizzazione scritta da parte di Porte IMIC Spa.





UNA STORIA INIZIATA NEL 1956... A STORY STARTED IN 1956...

...anno dopo anno
PORTE IMIC SPA si evolve
grazie ad una produzione "Made
in Italy" e sostenibile, realizzando
prodotti che impreziosiscono
l'abitare contemporaneo.
La Mission è quella di fornire
prodotti di alta qualità attraverso un
meticoloso controllo di ogni fase
del processo produttivo che
avviene interamente all'interno
dell'azienda e garantito da sofi-
sticate tecnologie di ultima gene-
razione associato alla manualità
di risorse umane che assicurano
cura nei minimi particolari.

...each year
PORTE IMIC SPA grows thanks to
a "Made in Italy" and ecologically
sustainable production.
The goal is providing high
quality products through a
meticulous check and coor-
dination of each phase of the
production system which is
completely made in house with
sophisticated up to date
technologies along with craft-
manship to ensure the attention
to details.

INDICE **INDEX**

8	GEOMETRIKA
30	SEVENTY
48	LINE
86	SHAPE
100	PLACE
110	FLAT
114	SISTEMA
120	MAXIMA
134	DOUBLE
142	SINERGY
150	MIMESY
170	MATERIKA
186	FINITURE <i>FINISHES</i>
188	MANIGLIE <i>HANDLES</i>
189	CERNIERE <i>HINGES</i>
191	INFORMAZIONI TECNICHE <i>TECHNICAL DATA SHEETS</i>

**“
I dettagli fanno
la perfezione e la
perfezione non è
un dettaglio.”**

Leonardo da Vinci

GEOMETRIKA

Anta Pantografata Pantographed door

Un'interpretazione della porta classica in chiave moderna, valorizzata dalla morbidezza della laccatura.

A contemporary take on the traditional door, enhanced by a smooth lacquered finish.



Collezione Geometrika, modello 703 G
Laccato Verde Agave
Geometrika Collection, model 703 G
Lacquered Green Agave



Collezione Geometrika, modello 703 G
Laccato Tortora
Geometrika Collection, model 703 G
Lacquered Brown Beige



Collezione Geometrika, modello 703 GV
Laccato Tortora con vano vetro
Geometrika Collection, model 703 GV
Lacquered Brown Beige with glass case



Collezione Geometrika, modello 704 G
Laccato Bianco Opaco
Geometrika Collection, model 704 G
Lacquered Matt White

Collezione Geometrika, modello 704 GV
Laccato Bianco Opaco con vano vetro
Geometrika Collection, model 704 GV
Lacquered Matt White with glass case



Collezione Geometrika modello 700 G
Laccato Bianco Opaco
Geometrika Collection, model 700 G
Lacquered Matt White



Collezione Geometrika modello 700 GV
Laccato Bianco Opaco con vano vetro
Geometrika Collection, model 700 GV
Lacquered Matt White with glass case



Collezione Geometrika, modello 850 G
Laccato Bianco Opaco
Geometrika Collection, model 850 G
Lacquered Matt White



Collezione Geometrika, modello 1600 G
Laccato Bianco Opaco
Geometrika Collection, model 1600 G
Lacquered Matt white



Collezione Geometrika, modello 702 G
Laccato Bianco Opaco
Geometrika Collection, model 702 G
Lacquered Matt White



Collezione Geometrika, modello 702 G
Laccato Bianco Opaco
Complanare con apertura inversa
Geometrika Collection, model 702 G
Lacquered Matt White
Rebated door with reverse opening



Collezione Geometrika, modello 900 G
Laccato Bianco Opaco
Geometrika Collection, model 900 G
Lacquered Matt White



Collezione Geometrika, modello 900 GV
Laccato Bianco Opaco con vano vetro
Geometrika Collection, model 900 GV
Lacquered Matt White with glass case



Collezione Geometrika, modello 710 G
Laccato Bianco Opaco
Geometrika Collection, model 710 G
Lacquered Matt White



SEVENTY

Anta Pantografata Pantographed door

Una porta che evoca sensazioni di leggerezza e compattezza, dove l'elemento decorativo "la pantografatura minimal" diventa essenziale nella definizione estetica.

A door recalls grace and stability, where the "minimal pantographed effect" becomes the distinguishing features.



Collezione Seventy, modello 240 PV
Laccato Grigio Lava con vetro satinato
Seventy Collection, model 240 PV
Lacquered Grey Lava with satin glass



Collezione Seventy, modello 240 P
Laccato Grigio Lava
Seventy Collection, model 240 P
Lacquered Grey Lava

Design Arch. Cono Ceraolo



Collezione Seventy, modello 240 P
Laccato *Blu Grey*
Seventy Collection, model 240 P
Lacquered Blue Grey



Collezione Seventy, modello 240 PV
Laccato *Blu Grey* con vetro satinato
Seventy Collection, model 240 PV
Lacquered Blue Grey with satin glass

Design Arch. Cono Ceraolo



Collezione Seventy, modello 220 P
Laccato Bianco Opaco
Seventy Collection, model 220 P
Lacquered Matt White



Collezione Seventy, modello 220 PV
Laccato Bianco Opaco con vetro satinato
Seventy Collection, model 220 PV
Lacquered Matt White with satin glass

Design Arch. Cono Ceraolo



Collezione Seventy, modello 210 P
Laccato Bianco Opaco
Seventy Collection, model 210 P
Lacquered Matt White



Collezione Seventy, modello 210 PV
Laccato Bianco Opaco con vetro satinato
Seventy Collection, model 210 PV
Lacquered Matt White with satin glass

Design Arch. Cono Ceraolo





Collezione Seventy, modello 260 P
Laccato Grigio Lava
Complanare con apertura inversa
Seventy Collection, model 260 P
Lacquered Grey Lava
Rebated door with reverse opening

Design Arch. Cono Ceraolo



Design Arch. Cono Ceraolo

Collezione Seventy, modello 290 P
Laccato Tortora
Seventy Collection, model 290 P
Lacquered Brown Beige



Collezione Seventy, modello 290 P
Laccato Grigio Luce
Rototraslante
Seventy Collection, model 290 P
Lacquered Light Grey
Swing door



LINE

Anta Incisa
Door leaf with lines

Un'estetica basata su linee che scompongono la superficie primaria conferendole semplicità e eleganza.

Horizontal lines engrave on a plain surface lend simplicity and elegance.



Collezione Line, modello 100 L
Scorrevole esterno muro "Magic"
Laccato Tortora
Con maniglia a Gola
Line Collection, model 100 L
On-wall sliding system "Magic"
Lacquered Brown Beige
With groove handle



Collezione Line, modello 100 L
Laccato Bianco Opaco
Line Collection, model 100 L
Lacquered Matt White



Collezione Line, modello 100 LV
Laccato Bianco Opaco con vano vetro
Line Collection, model 100 LV
Lacquered Matt White with glass case



Collezione Line, modello 100 L
Scorrevole esterno muro "Magic"
Laccato Grigio Lava
Line Collection, model 100 L
On-wall sliding system "Magic"
Lacquered Grey Lava



Collezione Line, modello 125 L
Scorrevole esterno muro "Magic"
Laccato Bianco Opaco
Line Collection, model 125 L
On-wall sliding system "Magic"
Lacquered Matt White

Design Arch. Cono Ceraolo



Collezione Line, modello 125 L
Laccato Bianco Opaco
Line Collection, model 125 L
Lacquered Matt White

Design Arch. Cono Ceraolo



Collezione Line, modello 102 L
Laccato Bianco Opaco
Line Collection, model 102 L
Lacquered Matt White



Collezione Line, modello 100 TL
Laccato Bianco Opaco
Line Collection, model 100 TL
Lacquered Matt White



Collezione Line, modello 195 L
Porta scorrevole esterno muro "Magic"
Laccato Grigio Lava
Line Collection, model 195 L
On-wall sliding system "Magic"
Lacquered Grey Lava

Design Arch. Cono Ceraolo



Collezione Line, modello 150 L
Laccato Grigio Luce
Line Collection, model 150 L
Lacquered Light Grey



Collezione Line, modello 180 L
Laccato Grigio Luce
Line Collection, model 180 L
Lacquered Light Grey



Collezione Line, modello 111 L
Laccato Bianco Opaco
Line Collection, model 111 L
Lacquered Matt White



Collezione Line, modello 111 LV
Laccato Bianco Opaco con vetro satinato
Line Collection, model 111 LV
Lacquered Matt White with satin glass

Design Arch. Cono Ceraolo



Collezione Line, modello 140 LV
Laccato Bianco Opaco con vetro satinato
Line Collection, model 140 LV
Lacquered Matt White with satin glass



Collezione Line, modello 140 L
Laccato Bianco Opaco
Line Collection, model 140 L
Lacquered Matt White



Dettaglio coprifilo da cm 10 lato esterno
Particular of external architrave from 10 cm



Collezione Line, modello 190 L
Laccato Grigio Seta
Line Collection, model 190 L
Lacquered Silk Grey

Design Arch. Cono Ceraolo



Collezione PORTE_24

Collezione Line, modello 130 L
Laccato Bianco Opaco
Line Collection, model 130 L
Lacquered Matt White



Design Arch. Cono Ceraolo

Collezione Line, modello 135 L
Laccato Bianco Opaco
Line Collection, model 135 L
Lacquered Matt White



Collezione Line, modello 165 L
Laccato Bianco Opaco
Line Collection, model 165 L
Lacquered Matt White

Design Arch. Cono Ceraolo



Collezione Line, modello 160 L
Laccato Bianco Opaco
Line Collection, model 160 L
Lacquered Matt White

Design Arch. Cono Ceraolo





Collezione Line, modello 170 L
Laccato Bianco Opaco
Line Collection, model 170 L
Lacquered Matt White

Design Arch. Cono Ceraolo



Collezione Line, modello 170 L
Complanare con apertura inversa
Laccato Grigio Lava
Line Collection, model 170 L
Rebated door with reverse opening
Lacquered Grey Lava



Design Arch. Cono Ceraolo

Collezione Line, modello 175 L
Laccato Blu Grey
*Line Collection, model 175 L
Lacquered Blue Grey*



SHAPE

Carattere contemporaneo, eleganza solenne per una porta che emana forte presenza, capace di influenzare la vostra abitazione.

Contemporary vibes and elegance embracing a charismatic nature. "Shape" doors will naturally influence your habitat.



Collezione Shape, modello 800 S
Laccato Blu Grey con superficie liscia
Shape Collection, model 800 S
Lacquered Blue Grey with smooth finish





Collezione Shape, modello 900 S
Laccato Tortora
con superficie effetto legno
*Shape Collection, model 900 S
Lacquered Brown Beige
with wood effect finish*





Collezione Shape, modello 1600 S
Laccato Tortora
con superficie effetto legno
Shape Collection, model 1600 S
Lacquered Brown Beige
with wood effect finish



Collezione Shape, modello 750 S
Laccato Avorio con superficie effetto legno
Shape Collection, model 750 S
Lacquered Ivory with wood effect finish



Collezione Shape, modello 110 S
Laccato Tortora
con superficie effetto dune
Shape Collection, model 110 S
Lacquered Brown Beige
with wood dune effect finish



Collezione Shape, modello 100 S
Laccato Bianco Opaco
con superficie effetto legno verticale ricavato
Shape Collection, model 100 S
Lacquered Matt White
with carved vertical wood effect finish



PLACE

Anta Pantografata *Pantographed door*

Unisce l'utilizzo intelligente della tecnologia al design classico per produrre immagini con effetto visivo tridimensionale che trasmettono piacere ed emozione.

The smart use of technology is combined with a classic design: it creates figures with three-dimensional visual effects that produce pleasant sensations.



Collezione Place modello 710 PV
Laccato Avorio con vano vetro
Place Collection, model 710 PV
Lacquered Ivory with glass case



Collezione Place modello 710 P
Laccato Avorio
Place Collection, model 710 P
Lacquered Ivory



Collezione Place modello 1600 P
Laccato Bianco Opaco
Place Collection, model 1600 P
Lacquered Matt White



Collezione Place modello 900 PV
Laccato Bianco Opaco con vano vetro
Place Collection, model 900 PV
Lacquered Matt White with glass case



Collezione Place modello 900 P
Laccato Bianco Opaco
Place Collection, model 900 P
Lacquered Matt White



Collezione Place modello 800 P
Laccato Bianco Opaco
Place Collection, model 800 P
Lacquered Matt White



Collezione Place modello 800 PV
Laccato Bianco Opaco con vano vetro
Place Collection, model 800 PV
Lacquered Matt White with glass case



FLAT

La laccatura arricchita da elementi decorativi che definiscono l'estetica dell'oggetto stesso.

The lacquered effect enhances the decorative style that defines the object itself.



Collezione Flat modello 100 A 1
Con inserto in alluminio
Laccato Bianco Opaco
Flat Collection, model 100 A 1
With aluminum insert
Lacquered Matt White



Collezione Flat modello 100 A 2
Con inserto in alluminio
Laccato Bianco Opaco
Flat Collection, model 100 A 2
With aluminum insert
Lacquered Matt White



Collezione Flat modello 100 A
Con inserto in alluminio
Laccato Bianco Opaco
Flat Collection, model 100 A
With aluminum insert
Lacquered Matt White

SISTEMA

La bellezza della semplicità
cambia il nostro modo di vivere
la casa.

*Beauty lies in simplicity changes
the way we live our life at home.*



Collezione Sistema modello 470 V 1
Laccato Bianco Opaco con vetro satinato
Sistema *Collection*, model 470 V 1
Lacquered Matt White with satin glass



Collezione Sistema modello 470 V 2
Laccato Bianco Opaco con vetro satinato
Sistema *Collection*, model 470 V 2
Lacquered Matt White with satin glass



Collezione Sistema modello 400
Laccato Bianco Opaco
Sistema *Collection*, model 400
Lacquered Matt White



Collezione Sistema modello 400 V
Laccato Bianco Opaco con vetro satinato
Sistema *Collection*, model 400 V
Lacquered Matt White with satin glass



MAXIMA

Forme classiche e design raffinato vengono enfatizzati dall'effetto massellato che conferisce ulteriore prestigio.

Classic shapes and sophisticated design are emphasised by a slatted wood effect that gives prestige.



Collezione Maxima modello 900 M
Versione con coprifilo Imperial (Optional)
Laccato Bianco Opaco
Maxima Collection, model 900 M
Version with Imperial architrave (Optional)
Lacquered Matt White





Collezione Maxima modello 900 M
Versione con coprifilo Royal (Optional)
Laccato Bianco Opaco
Maxima Collection, model 900 M
Version with Royal architrave (Optional)
Lacquered Matt White



Collezione Maxima modello 900 M
Laccato Bianco Opaco
Maxima Collection, model 900 M
Lacquered Matt White



Collezione Maxima modello 710 MV
Laccato Avorio con vano vetro
Maxima Collection, model 710 MV
Lacquered Ivory with glass case



Collezione Maxima modello 710 M
Laccato Avorio
Maxima Collection, model 710 M
Lacquered Ivory



Collezione Maxima modello 1600 M
Laccato Bianco Opaco
Maxima Collection, model 1600 M
Lacquered Matt White



Collezione Maxima modello 610 M
Laccato Bianco Opaco
Maxima Collection, model 610 M
Lacquered Matt White



DOUBLE

Un'esplosione di modernità,
accentuata dalla scanalatura
doppia.

*Our double groove effect is
an explosion of contemporary
design.*



Collezione Double modello 803 D
Laccato Tortora
Double Collection, model 803 D
Lacquered Brown Beige



Collezione Double modello 800 D
Laccato Bianco Opaco
Double Collection, model 800 D
Lacquered Matt White



Collezione Double modello 800 DV
Laccato Bianco Opaco con vano vetro
Double Collection, model 800 DV
Lacquered Matt White with glass case



Collezione Double modello 700 D
Laccato Tortora
Double Collection, model 700 D
Lacquered Brown Beige



SINERGY

Nella collezione Sinergy convivono e si incontrano in uno stile unico e moderno l'effetto materico valorizzato dalla morbidezza della laccatura.

In Sinergy collection the texture effect and the smoothness of lacquering live and come together in a unique and modern style.





Collezione Sinergy modello 100 TO
Laccato Bianco Opaco con effetto legno
Sinergy Collection, model 100 TO
Lacquered Matt White with wood effect



Collezione Sinergy modello 100 TO LB
Laccato Bianco Opaco con effetto legno
A libro con ante asimmetriche
Sinergy Collection, model 100 TO LB
Lacquered Matt White with wood effect
Folding with asymmetrical leaves



Collezione Sinergy, modello 270 V
Laccato Bianco Opaco con effetto legno
e vetro satinato
*Sinergy Collection, model 270 V
Lacquered Matt White with wood effect finish
and satin glass*



MIMESY

Porta Filomuro **Flush with the wall**

NATA PER ESSERE INVISIBILE

L'ambiente domestico oggi viene considerato sempre come un tutto unico. Per questo la porta acquisisce ulteriori connotati che non riguardano solo il design, i materiali impiegati, ma anche l'idea di armonizzarsi con ciò che ci circonda.

DESIGNED TO BE INVISIBLE

We consider our home to be a place that caters for all our needs. Taking this philosophy into consideration, this door has been designed with the same scrupulous style and quality to blend in with its surroundings to become «invisible».

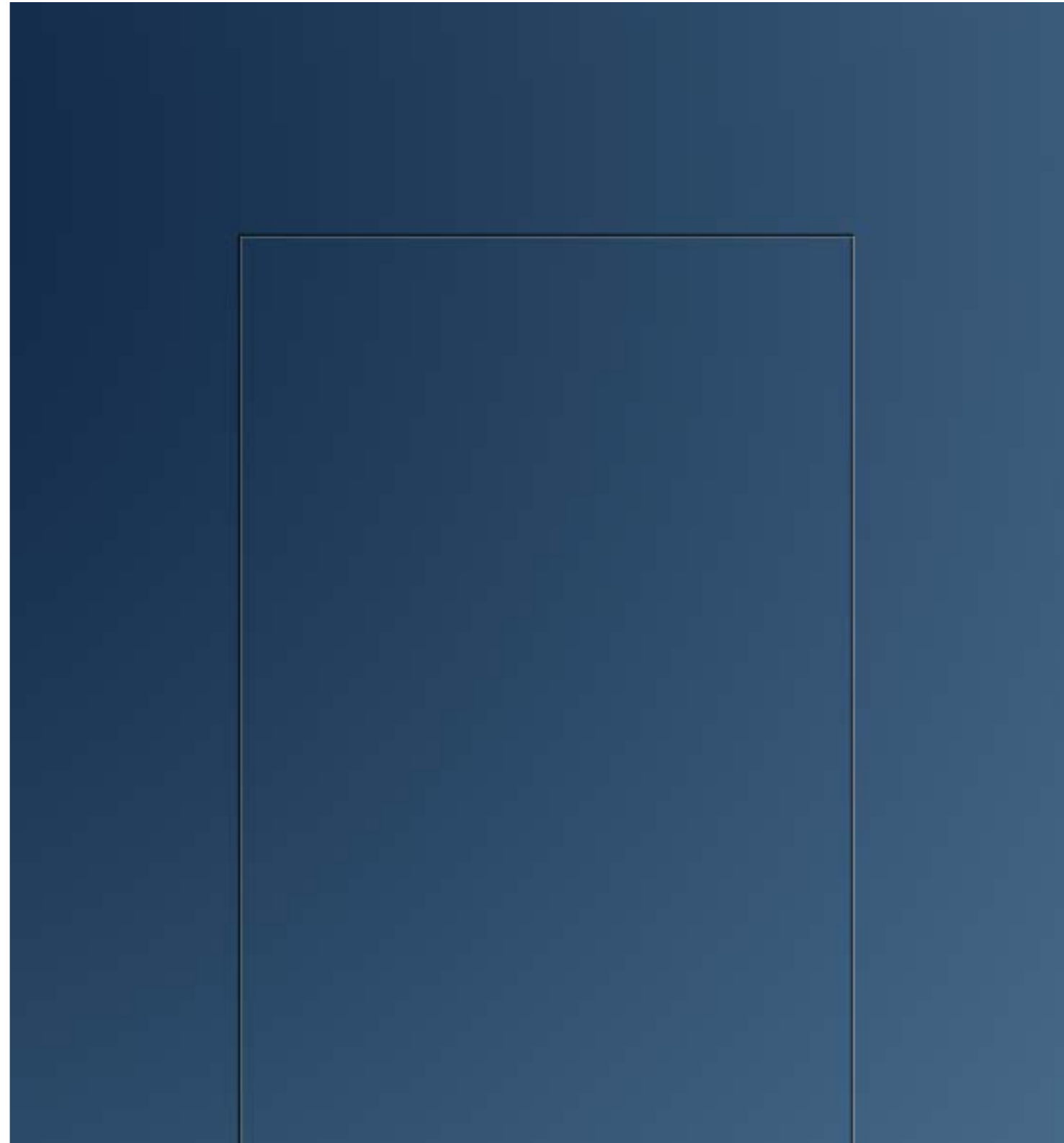

Collezione Mimesy modello 125 L
Laccato Bianco Opaco
Mimesy Collection, model 125 L
Lacquered Matt White

Design Arch. Cono Ceraolo



Collezione Mimesy modello 100 L
Finitura con primer
Mimesy Collection, model 100 L
With primer finish



Collezione Mimesy modello 100 L
Laccato Tortora Lucido
Mimesy Collection, model 100 L
Lacquered Brown Beige Gloss



Collezione Mimesy modello 165 L
Laccato Bianco Opaco
Mimesy Collection, model 165 L
Lacquered Matt White

Design Arch. Cono Ceraolo





Versione con maniglia Push a Filo (optional)
*Flush Door handle Push with
Hidden Frame (optional)*



Collezione Mimesy modello 160 L
Laccato Bianco Opaco
Mimesy Collection, model 160 L
Lacquered Matt White

Design Arch. Cono Ceraolo



Collezione Mimesy modello 100 L
Laccato Bronzo Satinato
Mimesy Collection, model 100 L
Lacquered Satin Bronze



Collezione Mimesy modello 100 L
Laccato Corten
Mimesy Collection, model 100 L
Lacquered Corten



Collezione Mimesy modello 175 L
Laccato Blu Grey
Mimesy Collection, model 175 L
Lacquered Blue Grey

Design Arch. Cono Ceraolo

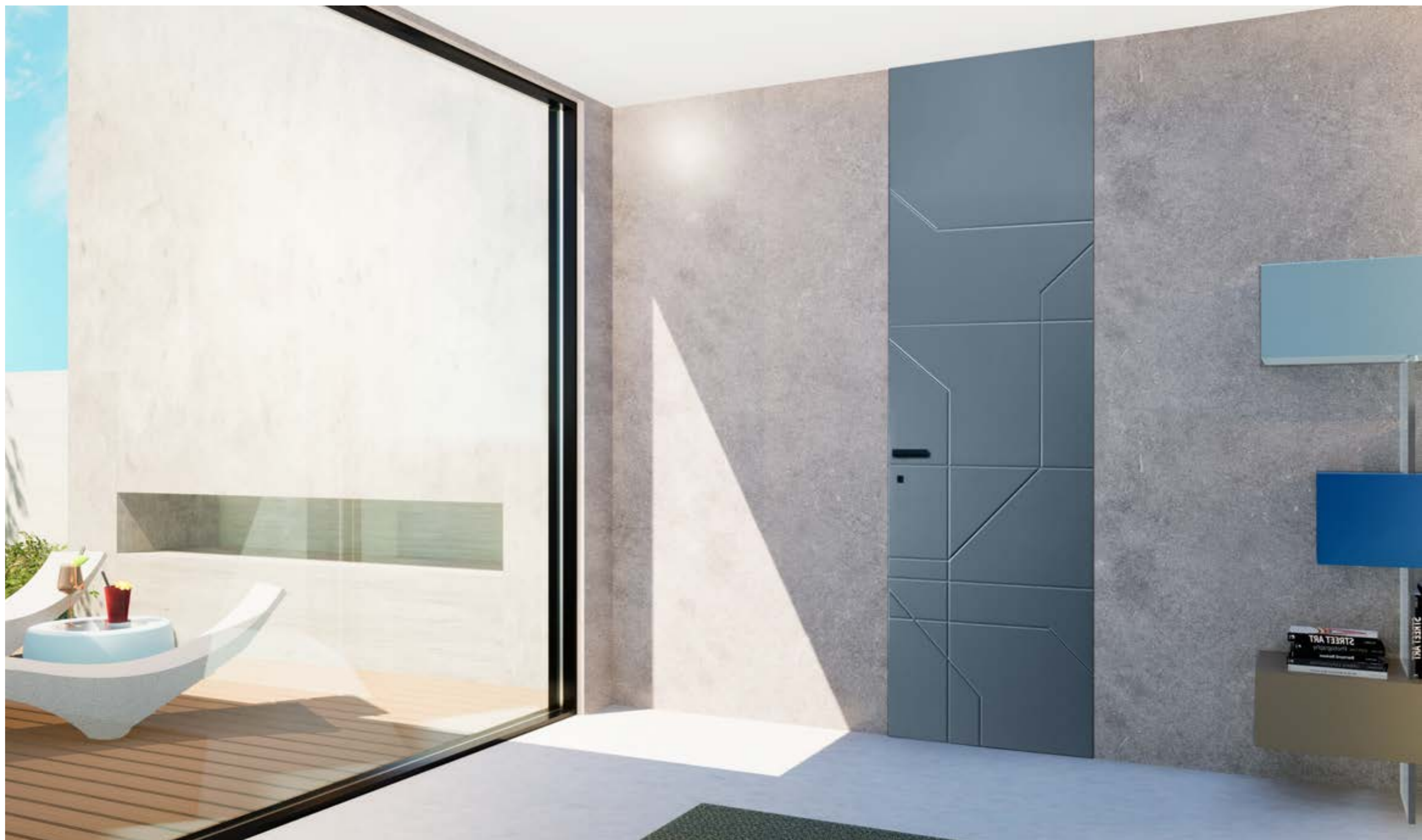

MATERIKA

La collezione Materika offre sensazioni tattili e visive dal carattere elegante e contemporaneo.

Materika collection offers tactile and visual sensations with an elegant and contemporary style.





Collezione Materika modello 100 TO
Bianco Azimut
Materika Collection, model 100 TO
Azimut White



Collezione Materika modello 270 V
Rovere Artico con vetro satinato
Materika Collection, model 270 V
Arctic Oak with satin glass



Collezione Materika modello 100 TO
Rovere Artico
Materika Collection, model 100 TO
Arctic Oak



Collezione Materika modello 270 V
Olmo Cenere con vetro satinato
Materika Collection, model 270 V
Ash Elm with satin glass



Collezione Materika modello 100 TO
Olmo Cenere
Materika Collection, model 100 TO
Ash Elm



Collezione Materika modello 100 TO
Rovere City Matrix
Materika Collection, model 100 TO
City Oak Matrix



Collezione Materika modello 470 V
Rovere City Matrix con vetro satinato
Materika Collection, model 470 V
City Oak Matrix with satin glass



Collezione Materika modello 100 TA 1
Rovere Artico con inserto in alluminio
Materika Collection, model 100 TA 1
Arctic Oak with aluminum insert



Collezione Materika
modello 100 TA 2
Materika Collection
model 100 TA 2



Collezione Materika
modello 100 TA 3
Materika Collection
model 100 TA 3



Collezione Materika
modello 100 TA
Materika Collection
model 100 TA

Collezione Materika modello 100
Bianco Opaco
Materika Collection, model 100
Matt White



Collezione Materika modello 100 TO
Noce Alter
Materika Collection, model 100 TO
Alter Walnut



FINITURE FINISHES

Laccati Lacquered



Bianco Opaco
Matt White

Grigio Luce
Light Grey

Avorio
Ivory

Grigio Seta
Grey Silk



Verde Agave
Green Agave

Blue Grey

Tortora
Brown Beige

Grigio Lava
Grey Lava



Su richiesta è possibile avere colori a campione RAL
RAL colours available on request

Laccati Lucidi Gloss Lacquered



Bianco Lucido
Gloss White

Grigio Luce Lucido
Gloss Light Grey

Avorio Lucido
Gloss Ivory

Grigio Seta Lucido
Gloss Grey Silk



Verde Agave Lucido
Gloss Green Agave

Blue Grey Lucido
Gloss Blue Grey

Tortora Lucido
Gloss Brown Beige

Grigio Lava Lucido
Gloss Grey Lava

FINITURE FINISHES

Laccati Shape Lacquered Shape



Bianco Opaco
Matt White

Grigio Luce
Light Grey

Avorio
Ivory

Grigio Seta
Grey Silk



Verde Agave
Green Agave

Blue Grey

Tortora
Brown Beige

Grigio Lava
Grey Lava

Laccati Metallo Metal Lacquered



Corten

Oro Satinato
Satin Gold

Bronzo Satinato
Satin Bronze

Materika



Bianco Opaco
Matt White

Bianco Azimut
White Azimut

Rovere Artico
Arctic Oak



Rovere City Matrix
City Oak Matrix

Olmo Cenere Matrix
Ash Matrix

Noce Alter
Alter Walnut

MANIGLIE HANDLES



Standard
alluminio
aluminum

Standard
cromata in alluminio
chrome aluminum

Maribo
cromo satinato
satın chrome

Vega
ottone lucido
polished brass

Vega
cromo satinato
satın chrome



Maribo
ottone lucido
polished brass

Dublin
cromo satinato
satın chrome

Los Angeles
cromo satinato
satın chrome

Q-Arte
cromo satinato
satın chrome

Q-Arte
nero opaco
matt black

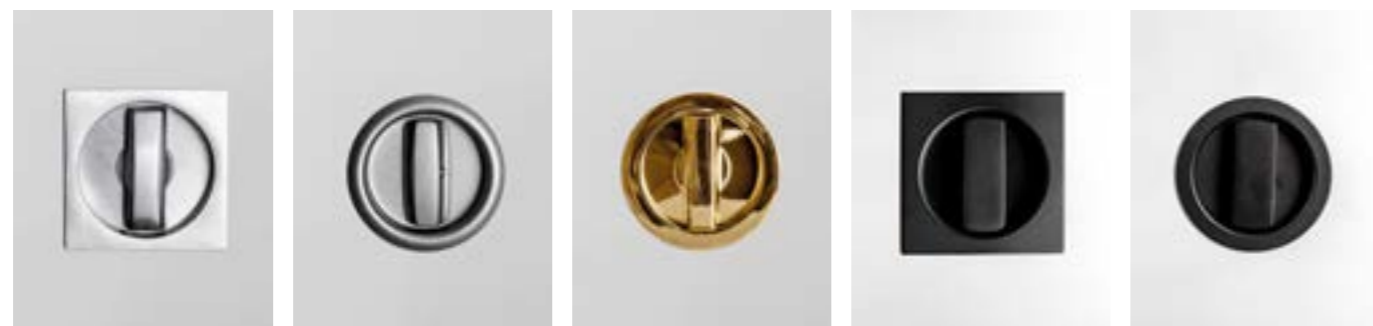

Nottolino quadro
Square turn lock
cromo satinato
satın chrome

Nottolino tondo
Round turn lock
cromo satinato
satın chrome

Nottolino tondo
Round turn lock
ottone
polished brass

Nottolino quadro
Square turn lock
nero opaco
matt black

Nottolino tondo
Round turn lock
nero opaco
matt black

CERNIERE HINGES

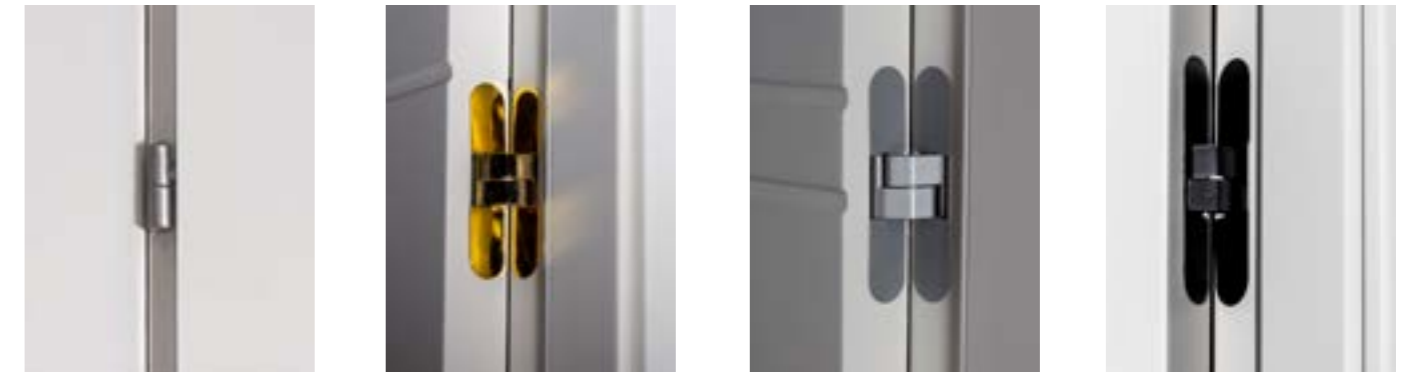

Anuba
Anuba hinges

A scomparsa
ottone lucido
Concealed hinges
polished brass

A scomparsa
cromo satinato
Concealed hinges
satın chrome

A scomparsa
nero opaco
Concealed hinges
matt black

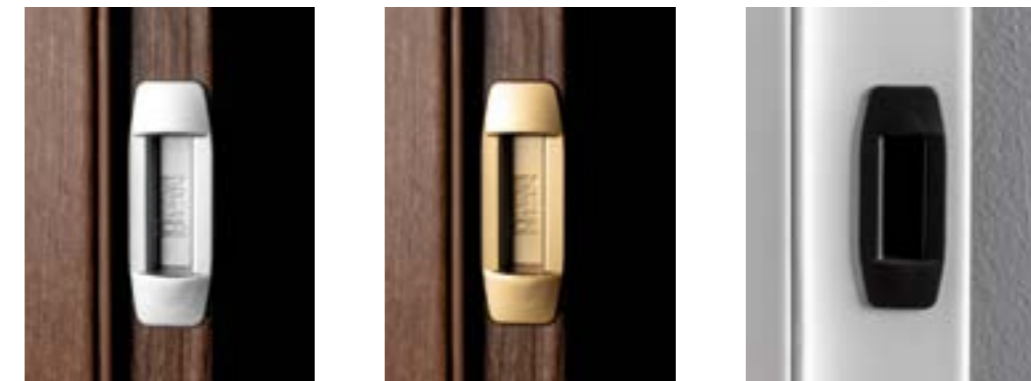

Contro Piastra
cromo satinato
satın chrome strike

Contro Piastra
ottonata
golden strike

Contro Piastra
nero opaco
matt black strike

Suggerimenti per la pulizia delle porte interne

La manutenzione e la pulizia delle porte interne è semplicissima e soprattutto non necessita di prodotti particolari e costosi. Per pulire le porte basta un semplice panno di casa inumidito con acqua e ben strizzato. Occorre passarlo con cura in tutte le parti della porta, compresa la maniglia. In alternativa ci sono tantissimi prodotti in commercio basta fare attenzione che non siano troppo aggressivi, quindi privi di agenti tipo ammoniaca, candeggina, etc. Lo si spruzza direttamente sul panno e si passa su tutta la porta.

Cleaning tips

Maintaining your interior door clean is very important and easy at the same time. It doesn't involve special nor expensive products: a simple, soft and humid rag will make the job. Just wipe it all over the door, handle included. As an alternative, you can always rely on commercial cleaners trying to avoid the ones containing ammonia or bleaching solutions. It's enough to spray it on the soft rug and wipe it all over the door.

INFORMAZIONI TECNICHE TECHNICAL DATA SHEETS

Porte IMIC si riserva il diritto di apportare, senza preavviso, ogni modifica mirata al miglioramento funzionale e qualitativo dei propri prodotti.

Testi e disegni presenti in questo catalogo hanno scopo divulgativo. I campioni colori e materiali hanno valore indicativo.

Porte IMIC reserve the right without prior notice to make adjustments to improve the efficiency and quality of our products. All text and illustrations are for advertising purposes. Colours and models shown are only an approximate indication of the product.

TIPOLOGIE DI APERTURA OPENING SYSTEMS

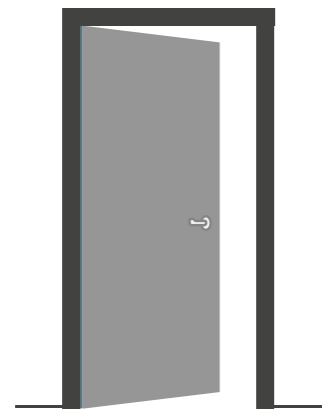

Porta Battente
Rebated Door

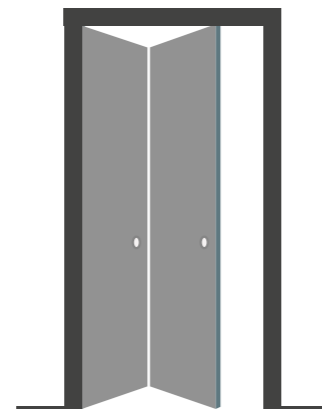

Porta a Libro
Folding Door

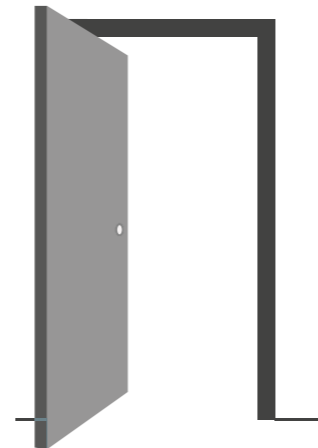

Porta Rototraslante
Pivoting Door

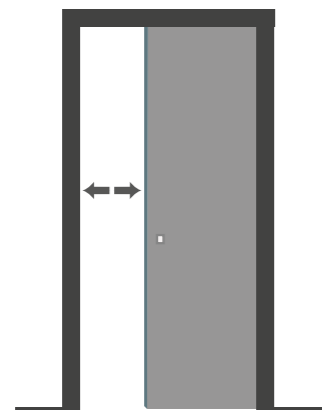

Porta Scorrevole
Interno Muro
In-Wall Sliding Door

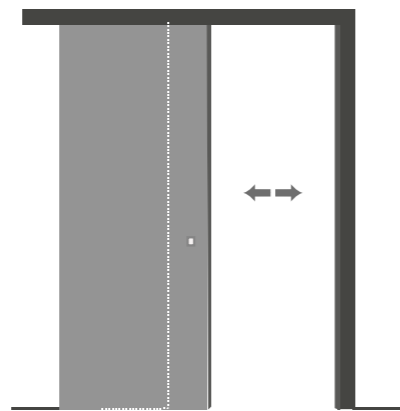

Porta Scorrevole
Esterno Muro
On-Wall Sliding Door

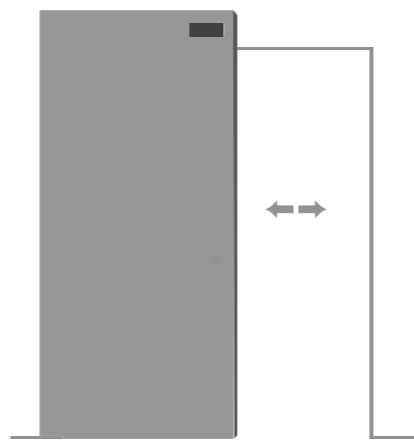

Porta Scorrevole
Esterno Muro Magic
On-Wall sliding door system MAGIC

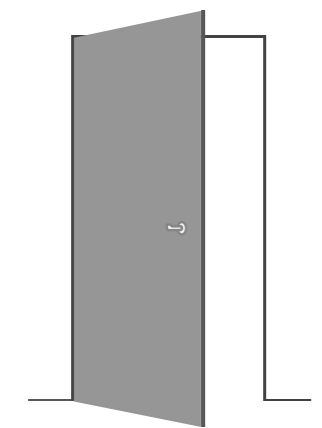

Porta Filo Muro a Tirare
Flush to Wall Door Pull Opening

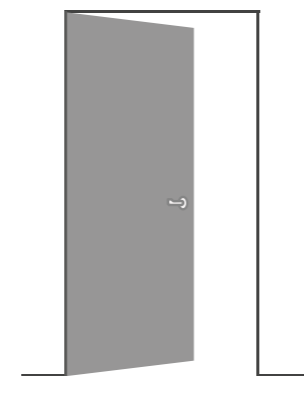

Porta Filo Muro a Spingere
Flush to Wall Door Push Opening

STRUTTURA ANTA DOOR LEAF STRUCTURE

TRUCIOLARE FORATO
TUBULAR CHIPBOARD

- LEGENDA
LEGEND
- HDF IDROFUGO
WATERPROOF HDF A
 - STRUTTURA PERIMETRALE IN LEGNO
LISTELLARE <<FINGER JOINT>>
<<FINGER JOINT>> STRIP B
 - TRUCIOLARE FORATO
TUBULAR CHIPBOARD C
 - HDF IDROFUGO
WATERPROOF HDF D

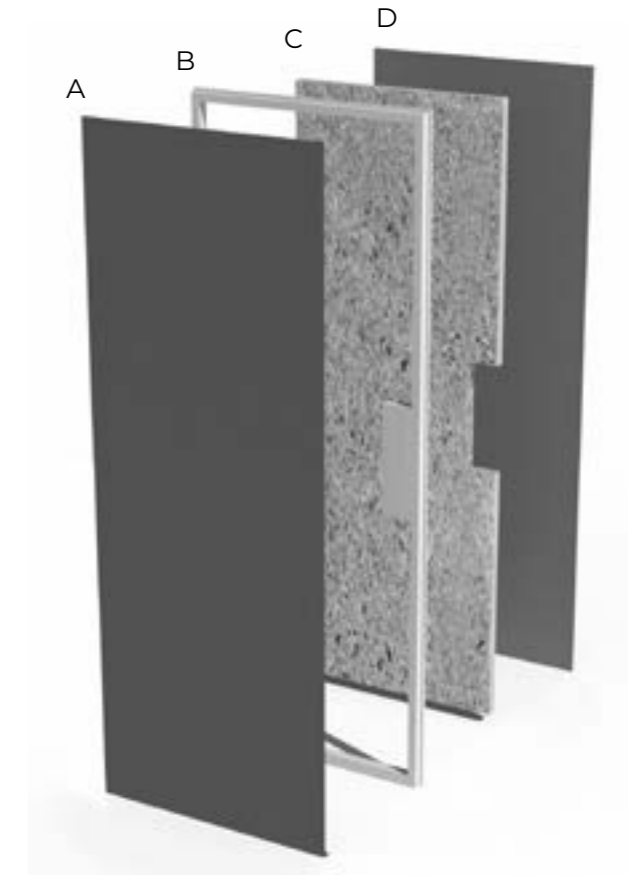

ALVEOLARE
HONEYCOMB LEAF

- LEGENDA
LEGEND
- HDF IDROFUGO
WATERPROOF HDF A
 - STRUTTURA PERIMETRALE IN LEGNO
LISTELLARE <<FINGER JOINT>>
<<FINGER JOINT>> STRIP B
 - STRUTTURA IN ALVEOLARE
HONEYCOMB STRUCTURE C
 - HDF IDROFUGO
WATERPROOF HDF D

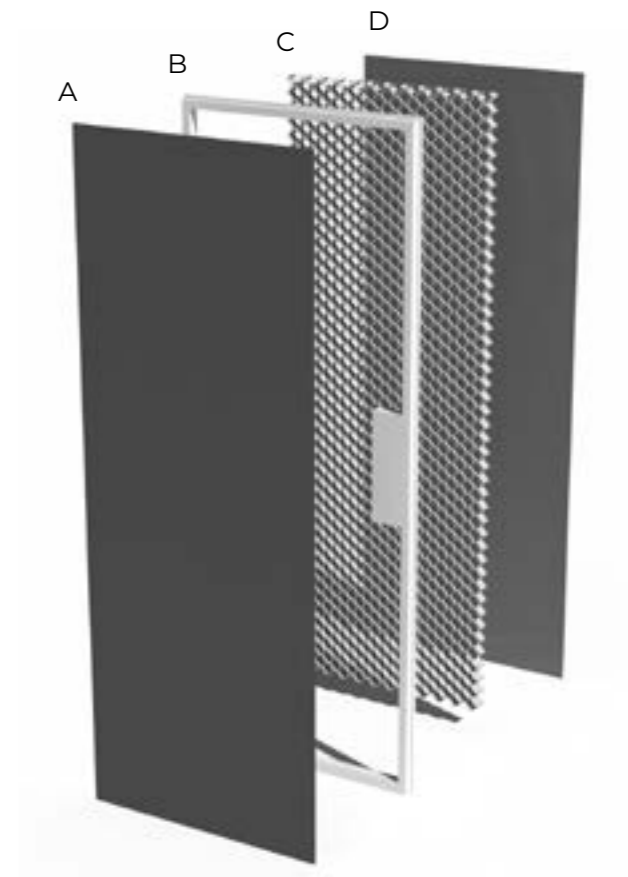

Porta battente
Rebated door

Sezione orizzontale
Horizontal section

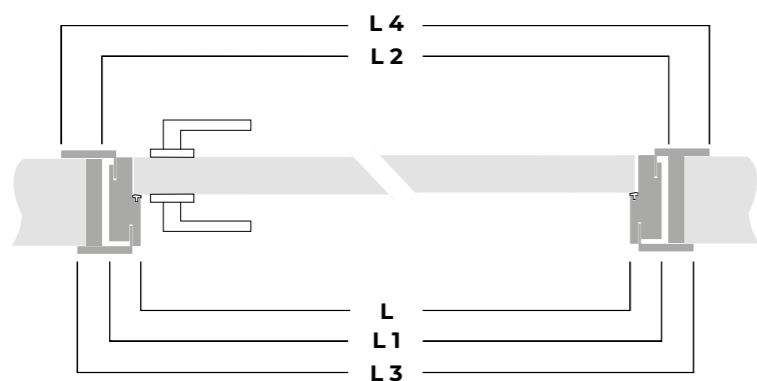

MISURE
MEASUREMENT

luce netta passaggio
internal jamb clear opening
L cm 80 cm 70 cm 60 H cm 210

esterno stipite
external jamb
L1 cm 88 cm 78 cm 68 H1 cm 214

Interno falso telaio
internal sub-jamb
L2 cm 90 cm 80 cm 70 H2 cm 215

esterno coprifili
external architrave
L3 cm 98 cm 88 cm 78 H3 cm 219
L4 cm 102 cm 92 cm 82 H4 cm 221

Sezione verticale
Vertical section

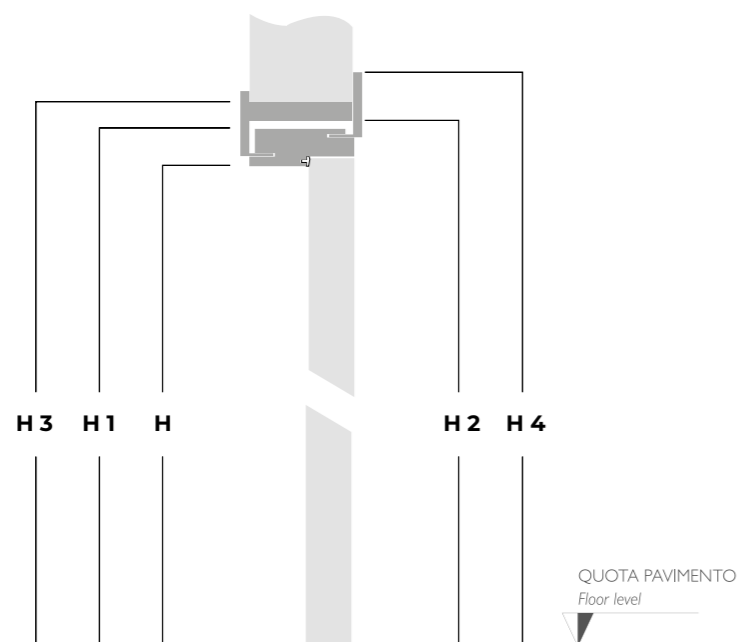

Apertura Destra
Right opening

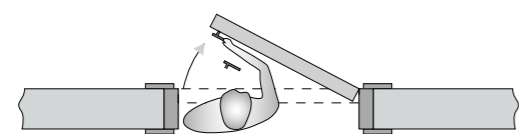

Apertura Sinistra
Left opening

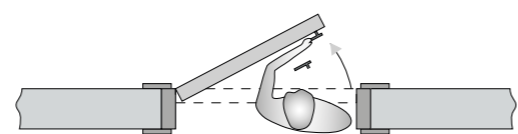

Porta complanare con apertura inversa
Flush to wall with reverse opening

Sezione orizzontale
Horizontal section

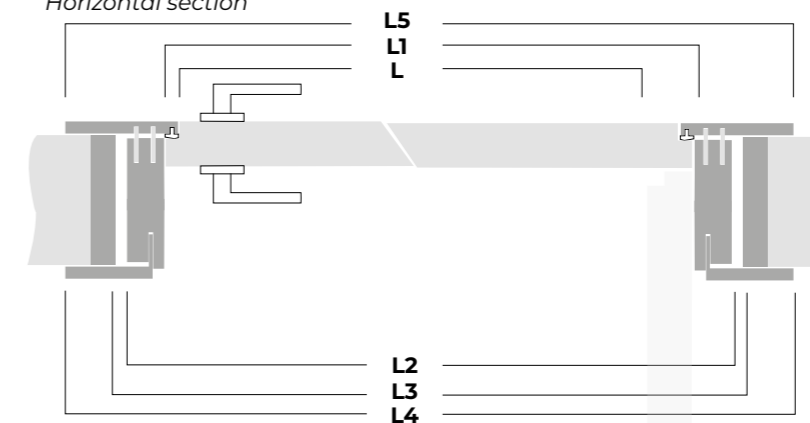

MISURE
MEASUREMENT

luce netta passaggio
internal jamb clear opening
L cm 74 cm 64 cm 54 H cm 209

Interno stipite
internal jamb
L1 cm 80 cm 70 cm 60 H1 cm 210

Esterno stipite
External jamb
L2 cm 88 cm 78 cm 68 H2 cm 214

Interno falso telaio
Internal sub-jamb
L3 cm 90 cm 80 cm 70 H3 cm 215

Esterno coprifili
External architrave
L4 cm 98 cm 88 cm 78 H4 cm 219
L5 cm 98 cm 88 cm 78 H5 cm 219

Sezione verticale
Vertical section

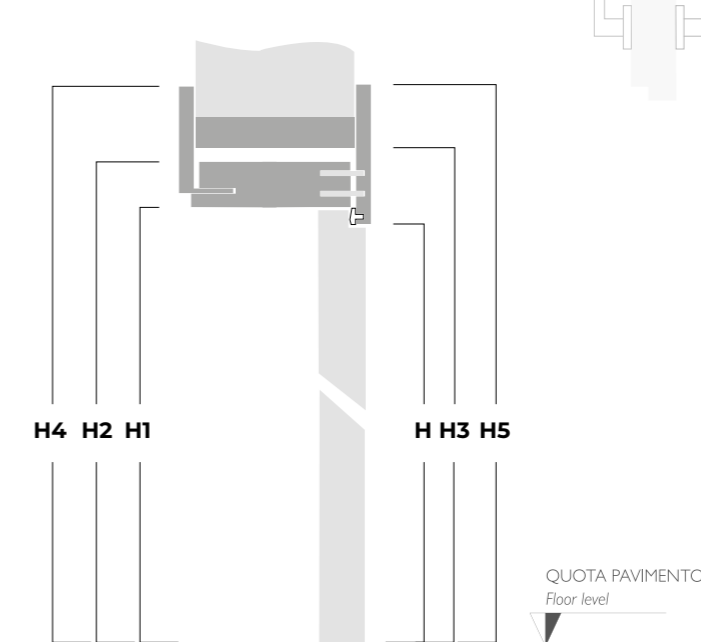

Apertura Destra
Right opening

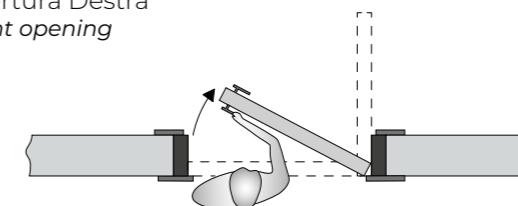

Apertura Sinistra
Left opening

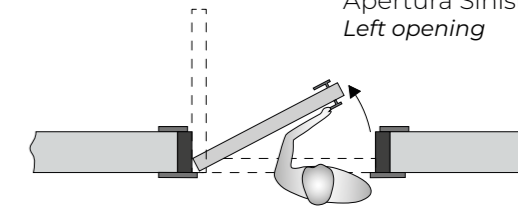

Porta scorrevole esterno muro con binario MAGIC
On wall sliding door MAGIC

Sezione orizzontale
 Horizontal section

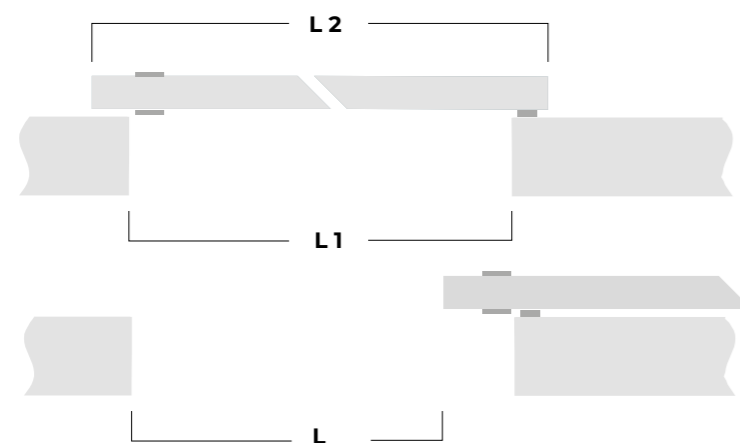

MISURE
MEASUREMENT

luce netta passaggio
 internal jamb clear opening
L cm 73 cm 63 cm 53 **H** cm 210

misura interno muro
 internal wall size
L1 cm 80 cm 70 cm 60 **H1** cm 210

Sezione verticale
 Vertical section

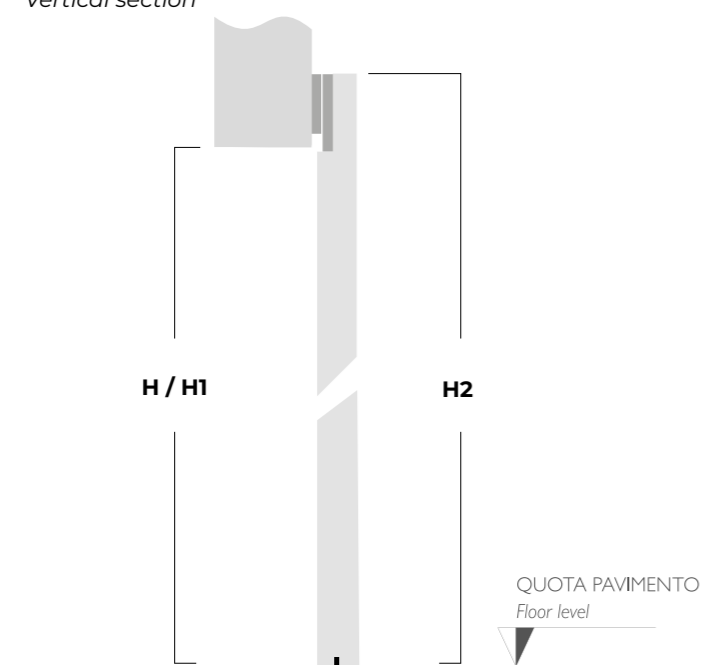

misura anta
 leaf size
L2 cm 90 cm 80 cm 70 **H2** cm 220

Apertura Destra
 Right opening

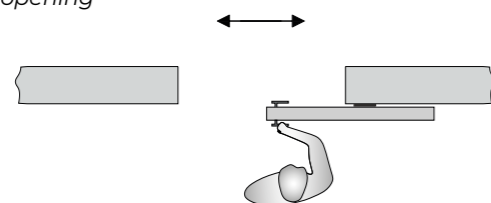

Apertura Sinistra
 Left opening

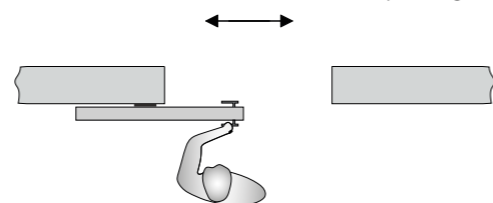

Porta scorrevole esterno muro
On wall sliding door

Sezione orizzontale
 Horizontal section

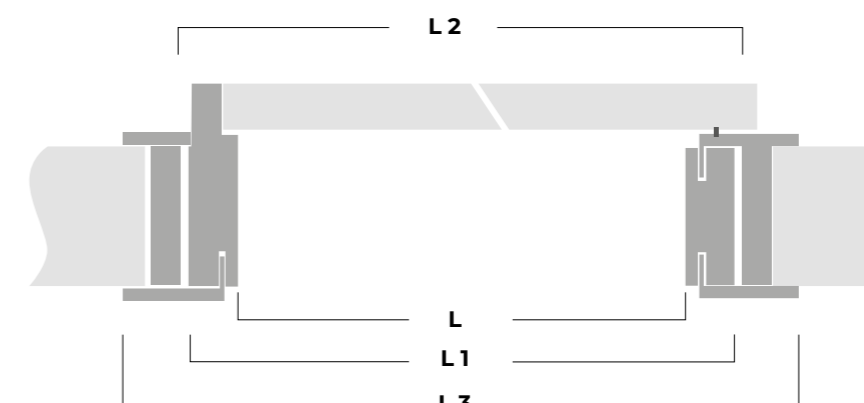

MISURE
MEASUREMENT

luce netta passaggio
 internal jamb clear opening
L cm 78,5 cm 68,5 cm 58,5 **H** cm 210

esterno stipite
 external jamb
L1 cm 86,5 cm 76,5 cm 66,5 **H1** cm 214

Sezione verticale
 Vertical section

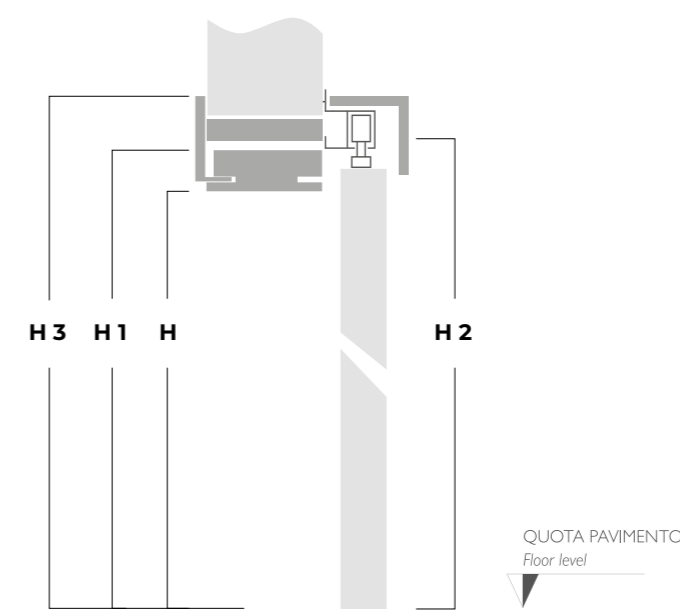

interno falsotelaio
 internal sub-jamb
L2 cm 88,5 cm 78,5 cm 68,5 **H2** cm 215

esterno coprifili
 external architrave
L3 cm 96,5 cm 86,5 cm 76,5 **H3** cm 219

Apertura Destra
 Right opening

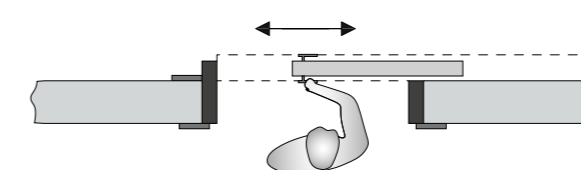

Apertura Sinistra
 Left opening

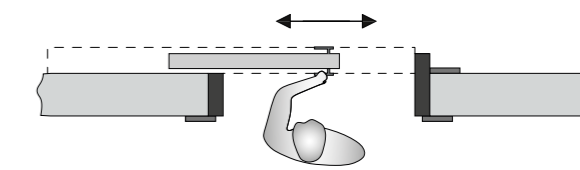

Porta a libro
Folding door

Sezione orizzontale
Horizontal section

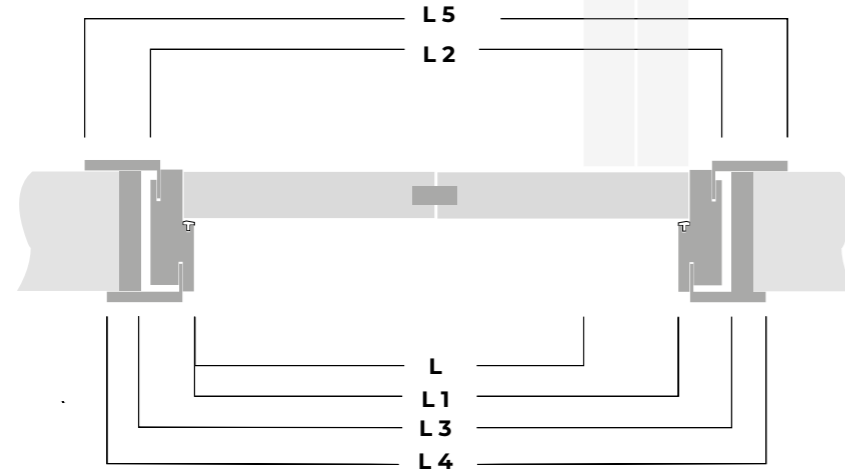

MISURE
MEASUREMENT

luce netta passaggio
internal jamb clear opening

L cm 72 cm 62 cm 52 **H** cm 210

interno stipite
internal jamb

L1 cm 80 cm 70 cm 60 **H1** cm 210

Esterno stipite
External jamb

L2 cm 88 cm 78 cm 68 **H2** cm 214

Interno falso telaio
Internal sub-jamb

L3 cm 90 cm 80 cm 70 **H3** cm 215

Esterno coprifili
External architrave

L4 cm 98 cm 88 cm 78 **H4** cm 219

L5 cm 102 cm 92 cm 82 **H5** cm 221

Sezione verticale
Vertical section

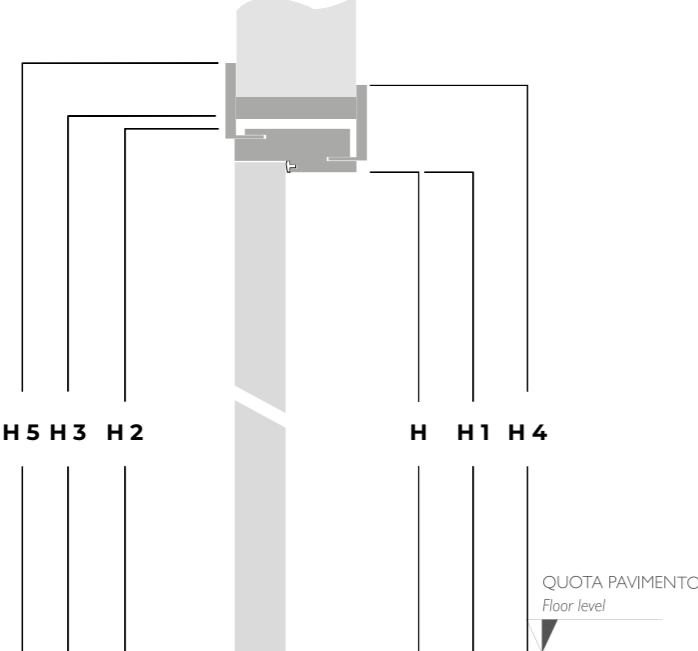

Apertura Destra
Right opening

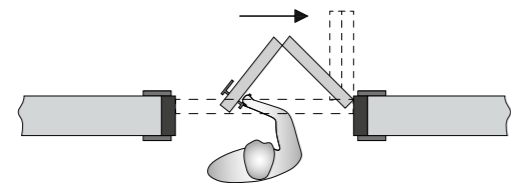

Apertura Sinistra
Left opening

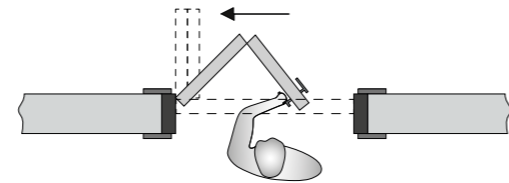

Porta rototraslante
Swing door

Sezione orizzontale
Horizontal section

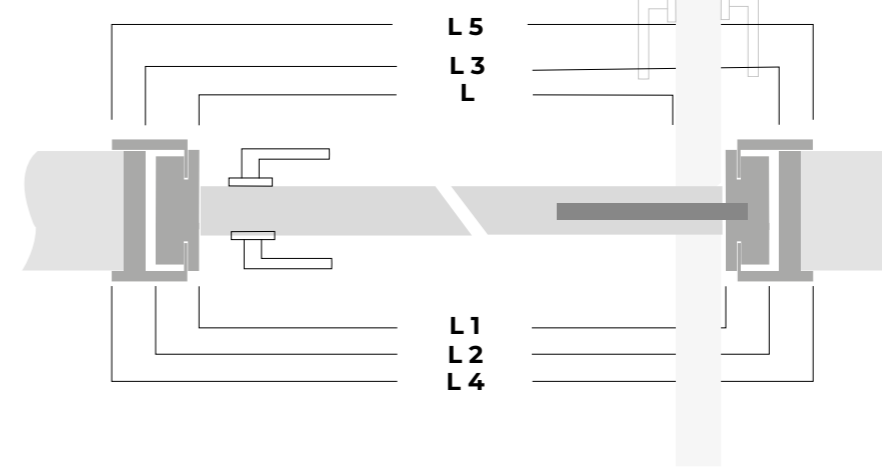

MISURE
MEASUREMENT

luce netta passaggio
internal jamb clear opening

L cm 75 cm 65 cm 55 **H** cm 210

Interno stipite
internal jamb

L1 cm 80 cm 70 cm 60 **H1** cm 210

Esterno stipite
External jamb

L2 cm 88 cm 78 cm 68 **H2** cm 214

Interno falso telaio
Internal sub-jamb

L3 cm 90 cm 80 cm 70 **H3** cm 215

Esterno coprifili
External architrave

L4 cm 98 cm 88 cm 78 **H4** cm 219

L5 cm 98 cm 88 cm 78 **H5** cm 219

Sezione verticale
Vertical section

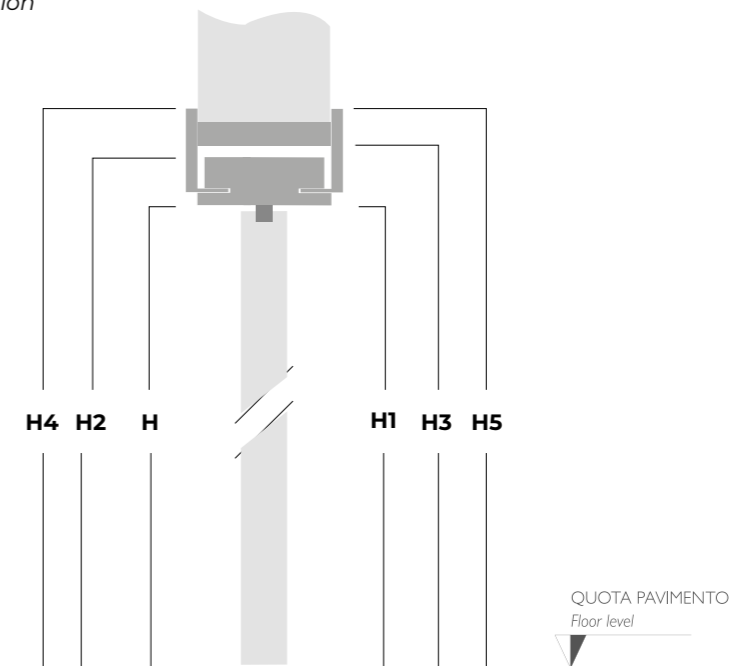

Apertura Destra
Right opening

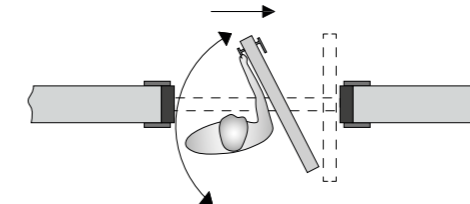

Apertura Sinistra
Left opening

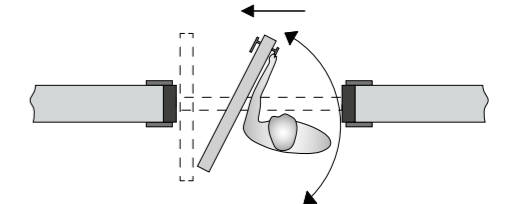

Porta scorrevole interno muro
Sliding door inside wall

Sezione orizzontale
Horizontal section

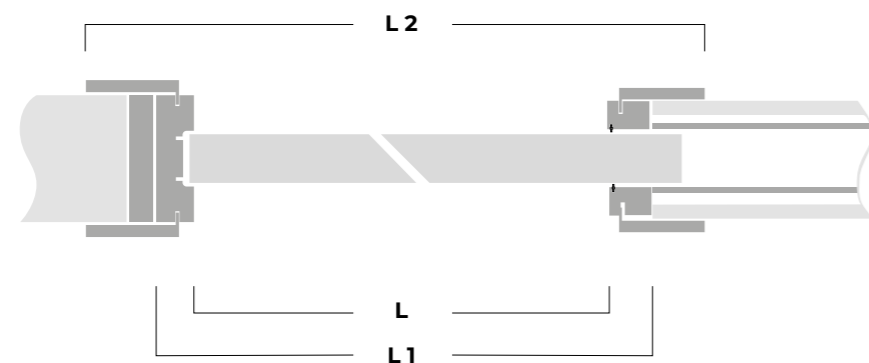

MISURE
MEASUREMENT

luce netta passaggio
internal jamb clear opening
L cm 80 cm 70 cm 60 **H** cm 210

interno stipite
internal jamb
L1 cm 85,5 cm 75,5 cm 65,5 **H1** cm 210

Sezione verticale
Vertical section

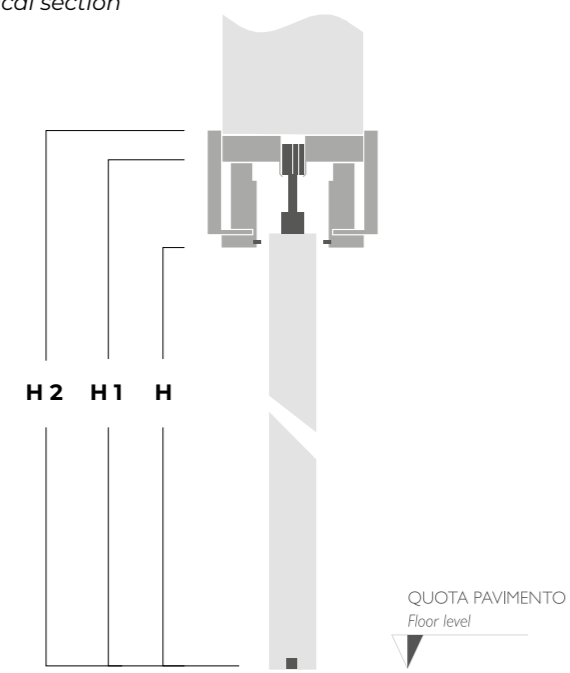

esterno coprifili
external architrave
L2 cm 98 cm 88 cm 78 **H2** cm 219

Apertura Destra
Right opening

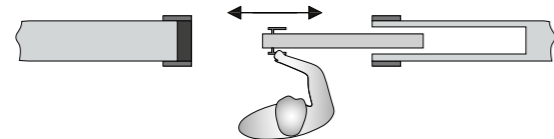

Apertura Sinistra
Left opening

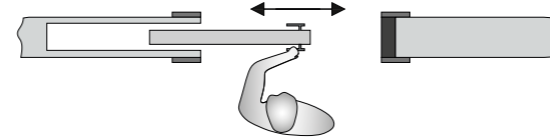

Porta Filo muro
Flush to wall door

Sezione orizzontale
Horizontal section

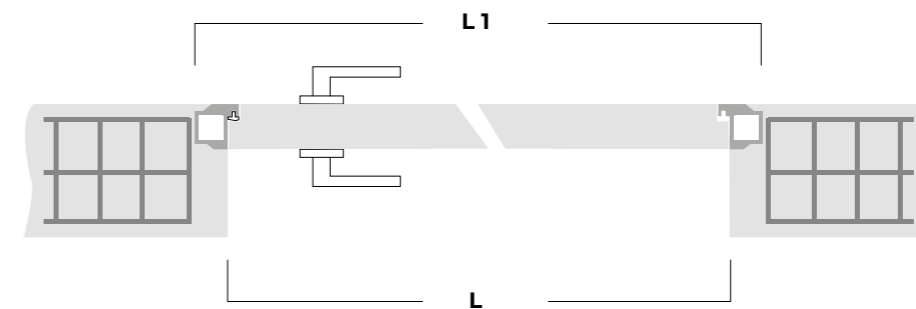

MISURE
MEASUREMENT

luce netta passaggio
internal jamb clear opening
L cm 80 cm 70 cm 60 **H** cm 210

Luce muratura
wall opening
L1 cm 90 cm 80 cm 70 **H1** cm 215

Sezione verticale
Vertical section

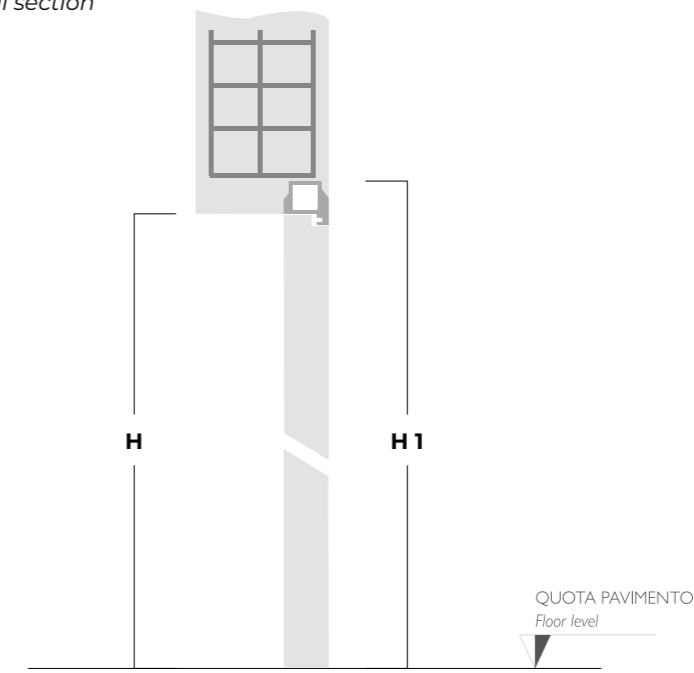

Apertura Destra
Right opening

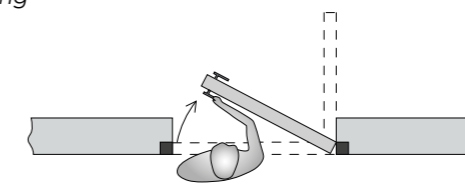

Apertura Sinistra
Left opening

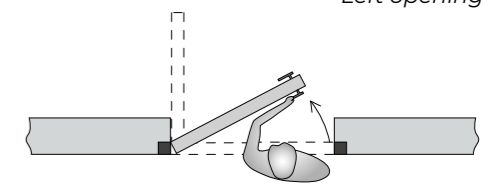

TIPOLOGIE STIPITI E COPRIFILI

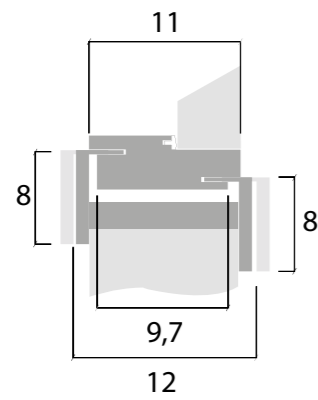

Stipite telescopico da cm. 11, coprifilo da cm. 8 lato esterno e lato interno con aletta da cm. 2,5
11 cm. Telescopic jamb, internal and external 8 cm. architrave with 2,5 cm. wing

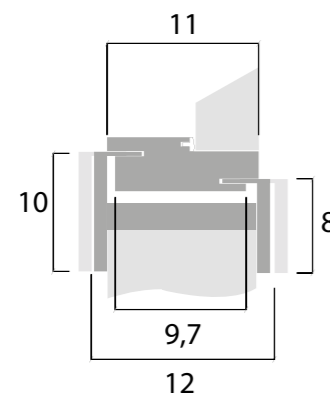

Stipite telescopico da cm. 11, coprifilo da cm. 8 lato esterno e lato interno con aletta da cm. 2,5
11 cm. Telescopic jamb, internal and external 8 cm. architrave with 2,5 cm. wing

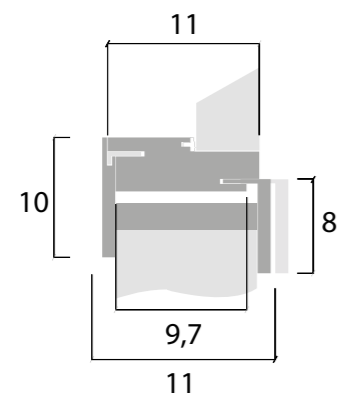

Stipite telescopico da cm. 11, coprifilo da cm. 8 lato esterno e lato interno con aletta da cm. 2,5
11 cm. Telescopic jamb, internal and external 8 cm. architrave with 2,5 cm. wing

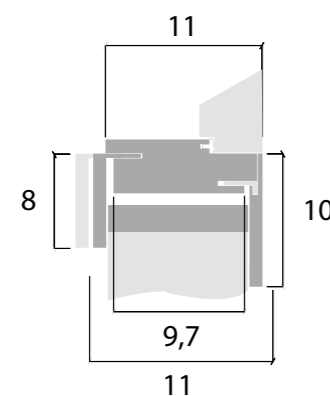

Stipite telescopico da cm. 11, coprifilo da cm. 8 lato esterno e lato interno con aletta da cm. 2,5
11 cm. Telescopic jamb, internal and external 8 cm. architrave with 2,5 cm. wing

TIPOLOGIE STIPITI E COPRIFILI

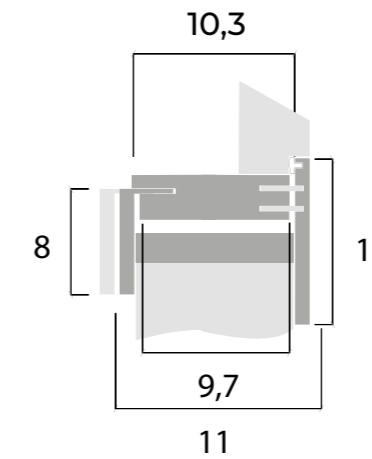

Stipite telescopico da cm.11, coprifilo da cm. 8 lato esterno e lato interno con aletta da cm. 2,5
11 cm. Telescopic jamb, internal and external 8 cm. architrave with 2,5 cm. wing

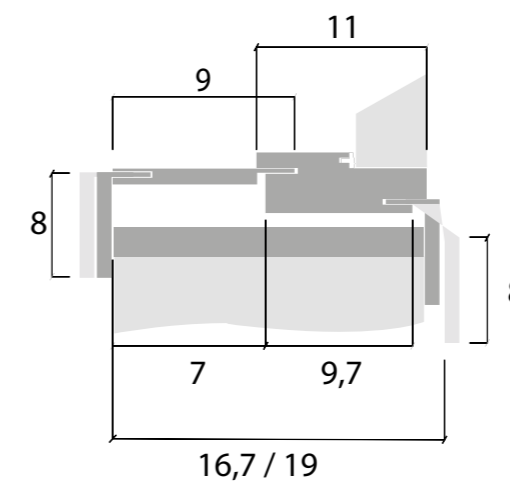

Stipite telescopico da cm.11, coprifilo da cm. 8 lato esterno e lato interno con aletta da cm. 2,5
11cm. Telescopic jamb, internal and external 8 cm. architrave with 2,5 cm. wing

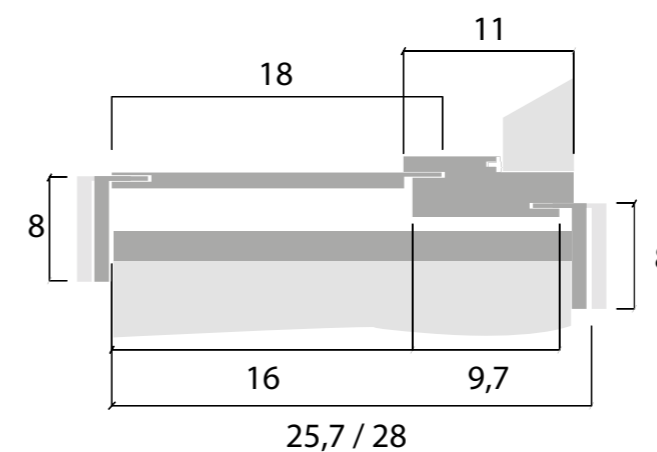

tipite telescopico da cm.11, con imbottito da cm.18 (Optional),coprifilo da cm.8 lato esterno e lato interno con aletta da cm. 2,5
11 cm. Telescopic jamb with 18 cm. extention (Optional), internal and external 8 cm. architrave with 2,5 cm. wing.

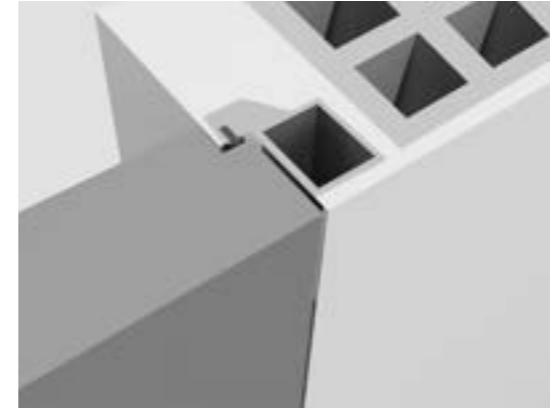
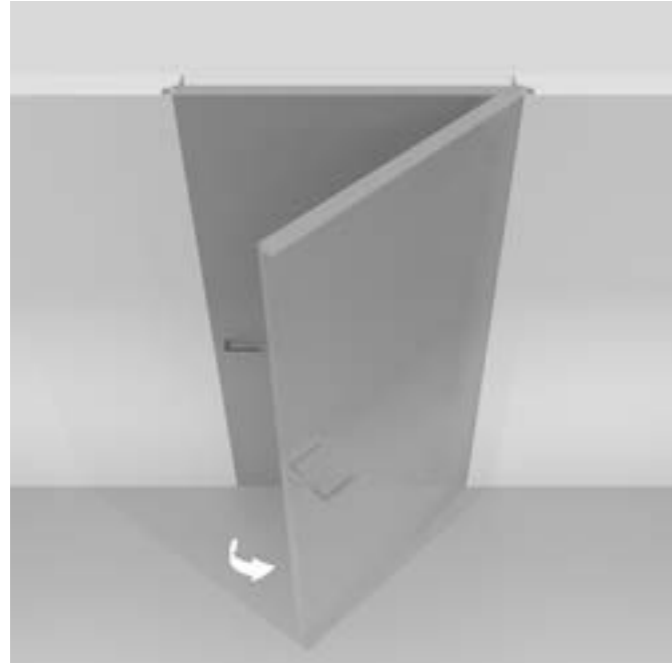

Porta filomuro lato esterno,
apertura a tirare
*Flush to wall door with outside
pull opening*

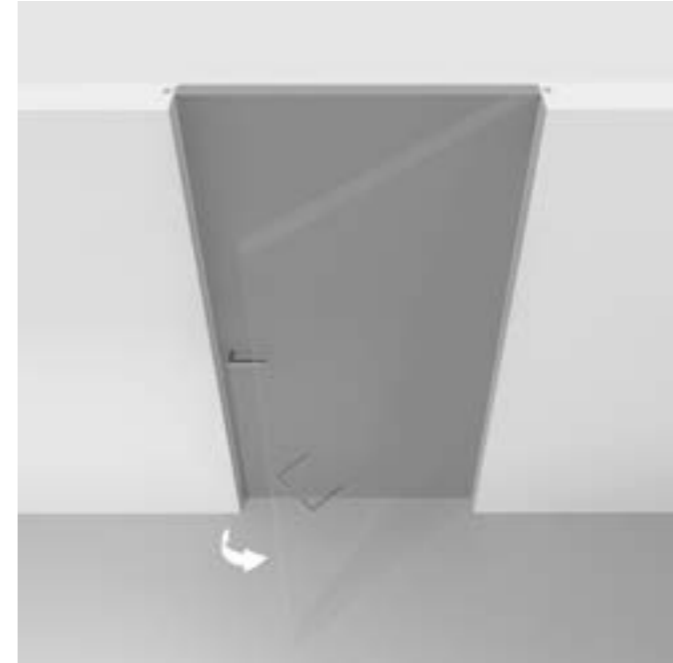

Porta filomuro lato interno,
apertura a tirare
*Flush to wall door with inside
pull opening*

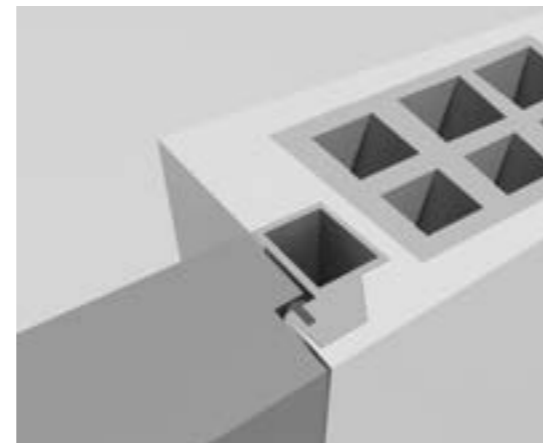

Porta filomuro lato esterno, apertura a
spingere
*Flush to wall door with outside push
opening*

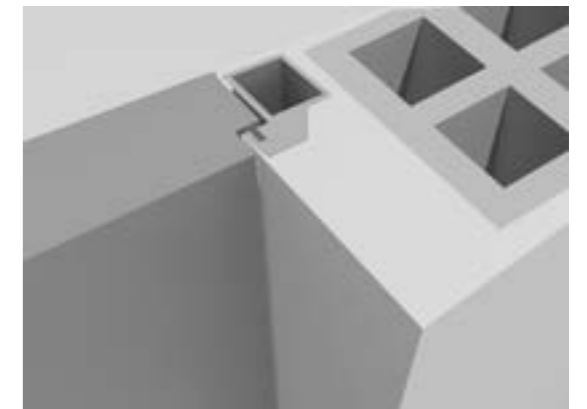

Porta filomuro lato interno,
apertura a spingere
*Flush to wall door with inside
push opening*



Sezione porta a battente con
cerniere anuba

*Section of rebated door with
anuba hinges*

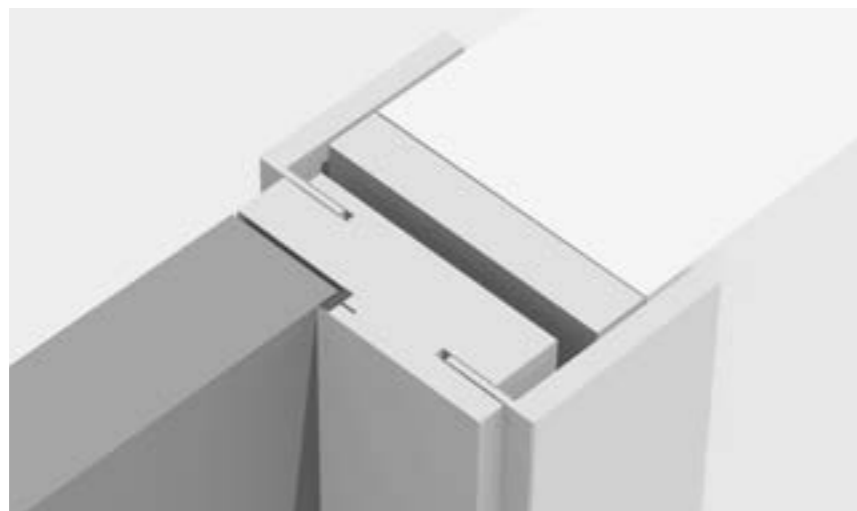

Sezione porta a battente con
cerniere a scomparsa

*Section of rebated door with
concealed hinges*



Sezione porta a battente con
coprifilo esterno da 10 cm

*Rebated door with external
architrave from 10 cm*

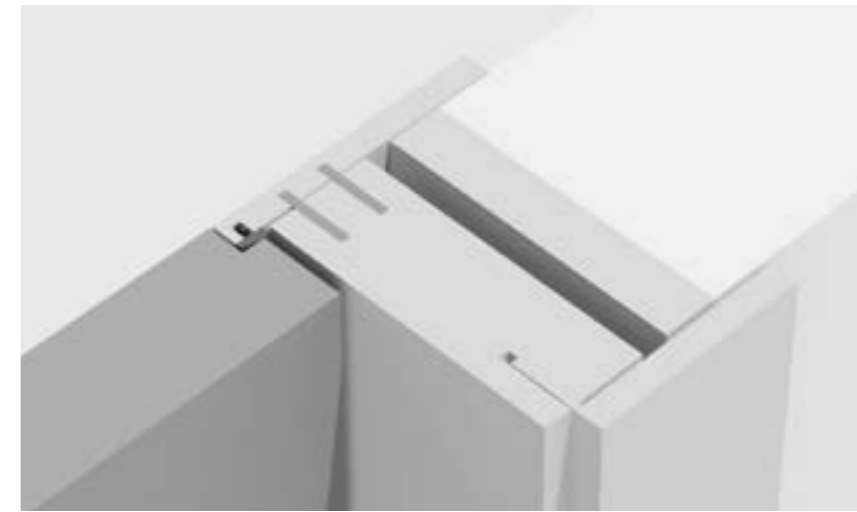

Sezione porta complanare
con apertura inversa

*Section of flush to wall door
with reverse opening*

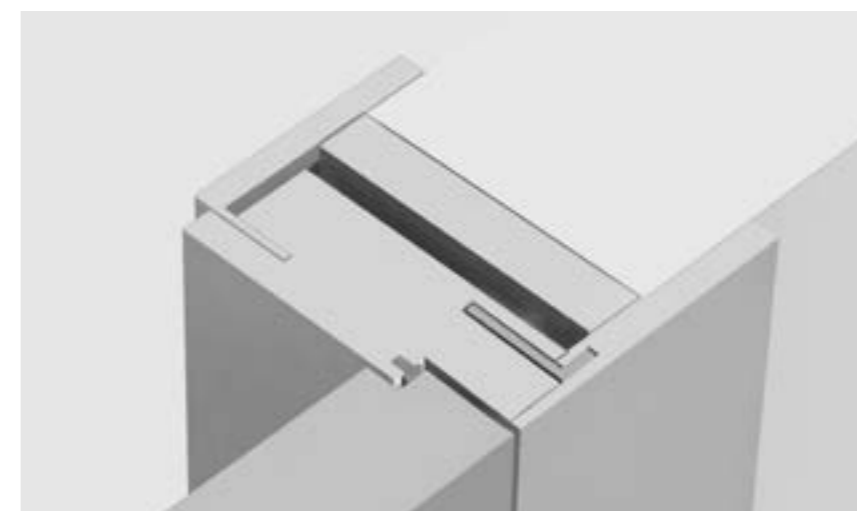

Sezione porta a battente
versione "plana"

*Rebated door "plana"
version*

NOTE:

COORDINATION,
CONCEPT AND STYLING:
ARCH. CONO CERAOLO

PHOTOGRAPHER:
NINO BARTUCCIO

GRAFIC DESIGNER:
MICHELE SPATICCHIA
OFFICINE CREATIVE DIGITALI

SEDE E STABILIMENTO:
CONTRADA ZAPPULLA
98070 TORRENOVA
(MESSINA) ITALIA
TEL. +39 0941 958266 PBX
TELEFAX +39 0941 958485
info@porteimic.com

porteimic.com

